







CL.1 Concealed two-way diverter - Chrome

CL.1

36 201 705



- with WAVES structure
- rotary diverter
- rosette 60 x 60 mm
- with shut-off function

	Chrome	36 201 705-00 0010
	Brushed Platinum	36 201 705-06 0010
	Dark Chrome	36 201 705-19 0010
	Brushed Champagne (22kt Gold)	36 201 705-46 0010
	Champagne (22kt Gold)	36 201 705-47 0010
	Brushed Dark Platinum	36 201 705-99 0010

Required miscellaneous



- | | |
|-------------------------------------|---------------|
| Concealed two-way diverter - | 35 202 970-90 |
| •max. recess depth 160 mm | 0010 |
| •min. recess depth 115 mm | |

36 201 705

mm [inches]

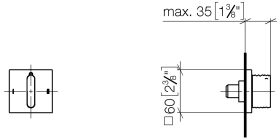

Flow rate chart



Codes & Standards

California Energy
Commission
(CEC)



CL.1 Concealed two-way diverter - Chrome

CL.1

36 201 705

Certificates

IAPMO_4976 (7).

36 201 705

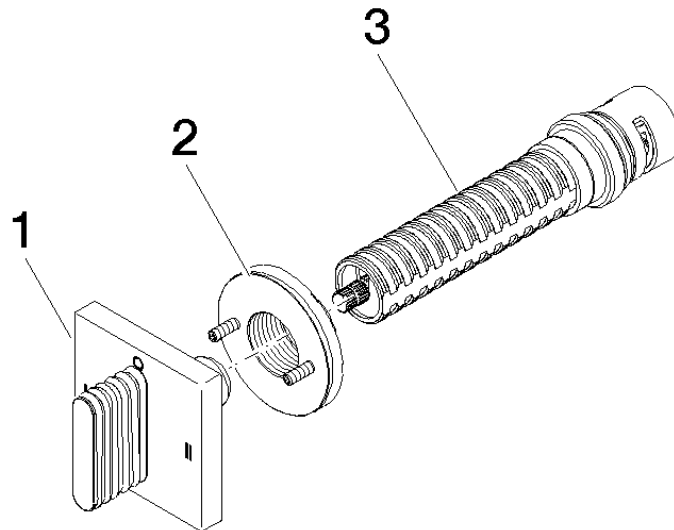

Spare parts list

No.	Item Number	Name	Quantity used	Delivery time
1	90 20 70 055 09-00	handle	1	10
2	90 21 02 181 00 90	disc	1	2
3	90 90 03 306 10 90	diverter	1	2